

Operating Manual

Planetary Gearbox

EPL

EPL50X – 155X

EPL-Q

EPL-SA

EPL-FE

ESP-L

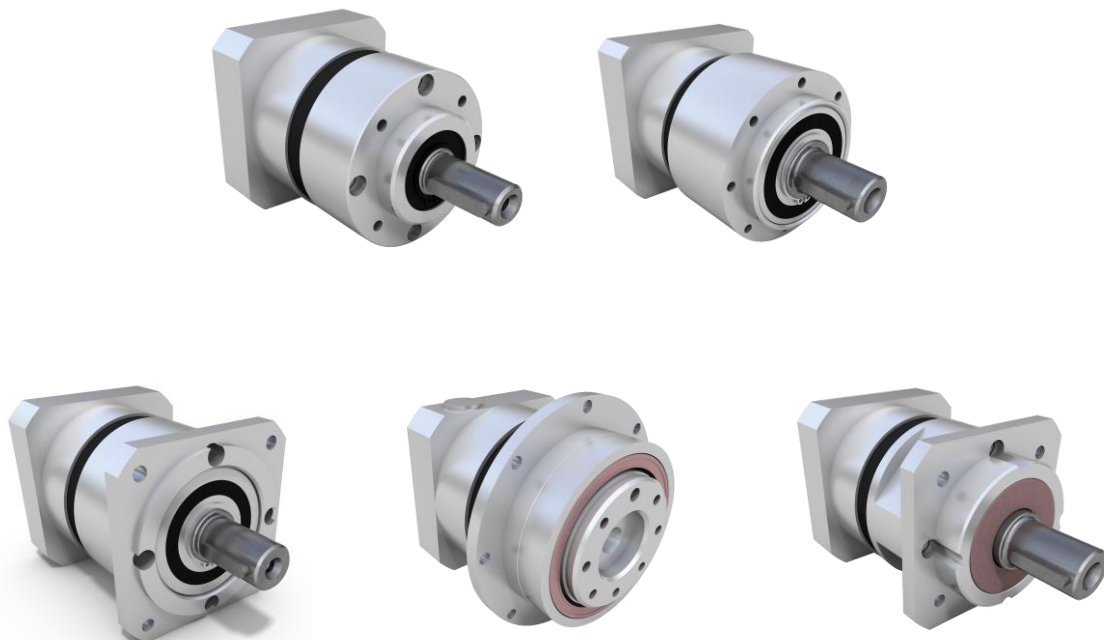

Table of contents

1	Introduction.....	3
1.1	General information	3
1.2	Warning and safety information	3
2	Safety instructions.....	4
2.1	Machinery Directive	4
2.2	Intended use.....	4
2.3	General safety information	4
3	Product description.....	5
3.1	Planetary gearbox components.....	5
3.2	Lubrication.....	6
3.3	Operating temperature	6
3.4	Technical data.....	6
4	Delivery and handling.....	6
4.1	Delivery condition.....	6
4.2	Transport	6
4.3	Storage.....	6
5	Assembly and Installation	7
5.1	Motor assembly.....	7
5.2	Attaching couplings, toothed pulleys, etc.	7
5.3	Installation.....	7
6	Commissioning and operation	7
6.1	Precautions before commissioning	7
6.2	Operating temperature	7
6.3	Sound emission.....	8
7	Maintenance	8
7.1	Maintenance intervals.....	8
7.2	Grease change	8
7.3	Recommissioning after testing or maintenance.....	8
8	Disposal	9

1 Introduction

This document contains important information about safe usage of the Eisele planetary gearbox from series EPL, EPL50X-155X, EPL-Q, EPL-SA, EPL-FE und ESP-L. For simple understanding, all series of the planetary gearboxes will be referenced as planetary gearbox.

1.1 General information



The operator must make sure that every person, commissioned in assembly, operation or maintenance has read and understood this operating manual.

The manual must be kept accessible and close to the planetary gearbox. The safety instructions have to be paid attention to by every person working in its environment.

The original version of this document was created in German language, any other language versions are translations of this document.

1.2 Warning and safety information







This operating manual contains warning and safety information, which hints at possible personal or property damage. The following signal words indicate the severity of the given danger.

Signal word	Meaning	Consequences if disregarded
 Warning!	Potential danger	Serious to fatal injuries
 Caution!	Potential danger	Minor injuries
Notice	Potential danger	Damage to the product or the environment

All warnings are structured as follows:

Safety symbol	Signal word
	Description of the danger including the possible consequences <ul style="list-style-type: none"> ▪ Measures to avoid danger

The following safety symbols are used in this operating manual:

 General danger	 Automatic start-up	 Danger of being dragged in	 Environmental hazard
 Hand injuries	 Crushing danger	 Hot surfaces	

2 Safety instructions

The entire manual, especially the safety instructions, must be considered by every person working with the planetary gearbox. In addition, all legal regulations, in particular regarding accident prevention and environmental protection, must be followed.

2.1 Machinery Directive

According to the EU Directive 2006/42/EG, planetary gearbox units are machine components. It is therefore neither a machine nor an incomplete machine, but rather components for installation in machines and systems.

The planetary gearbox units are not subject to the Machinery Directive. A CE marking and a conformity guideline according to the Directive 2006/42/EG are not permitted for the planetary gearboxes.

The commissioning of the planetary gearbox is not permitted within the scope of the Machinery Directive until it has been established that the machines and systems in which the planetary gearbox is going to be installed comply with the provisions of Directive 2006/42/EG.

2.2 Intended use

The planetary gearboxes are designed for converting rotational speed and torque in electrical machines, systems and components intended for industrial and commercial use. The gearboxes are designed to be mounted to electric motors.

When installing the gearbox unit in electrical machines and systems, commissioning is only permitted once it is clearly established that all local laws and guidelines are being followed.

Improper use of the planetary gearbox can lead to serious personal and property damage. The gearboxes may only be used within their technical performance data. Exceeding the technical data can lead to immediate or creeping damage to the planetary gearbox. Any exceeding of the technical data is not permitted; this is considered improper use.

2.3 General safety information

	⚠ Warning!
	<p>Incorrect assembly and utilization, improper use and inadequate maintenance can lead to serious property damage and severe injuries or even death.</p> <ul style="list-style-type: none"> ▪ All following safety instructions must be observed. ▪ The use of the planetary gearboxes is only permitted according to the intended use and by consideration of the technical data.

	⚠ Warning!
	<p>Rotating components of the planetary gearboxes can sling away. This can lead to severe damage and injuries or even death.</p> <ul style="list-style-type: none"> ▪ All tools and assembly aids must be removed before commissioning the planetary gearboxes. ▪ Keys and other components on the shafts that are detachably connected must be removed or covered before starting if they are not secured by the attachment.

	<p>⚠ Warning!</p>
	<p>Rotating components of the planetary gearboxes can pull in body parts. This can lead to severe injuries or even death.</p> <ul style="list-style-type: none"> ▪ Before starting up and during the entire operation, a sufficient distance must be maintained to all rotating gearbox parts and attachments. ▪ Assembly and maintenance work may only be carried out when the planetary gearbox is at standstill and when appropriate safety precautions have been met, for example securing the entire system against starting up or unintentional movement.

	<p>Notice</p>
	<p>Leaking operating fluids and lubricants and improper disposal can cause environmental damage.</p> <ul style="list-style-type: none"> ▪ Leakages must be prevented during handling, storing, operation, maintenance and disposal. ▪ The planetary gearboxes must be disposed of properly.

3 Product description

The Eisele planetary gearboxes of the ESP series are single or two-stage low backlash planetary gearboxes. The drive motor is attached using an integrated clamp connection within the gearbox and a motor-specific adapter plate. The planetary gearboxes are sealed on both sides and are equipped with lifetime lubrication.

3.1 Planetary gearbox components

The components of the planetary gearboxes are presented in the following representation. The representation only shows an exemplary planetary gearbox structure. Depending on the series, size and variant of the planetary gearboxes, these may differ in shape and design.

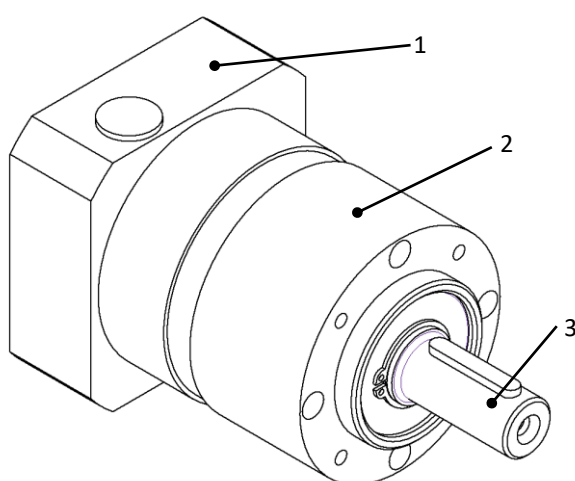

- 1: Adapter plate for motor assembly
- 2: Gearbox housing
- 3: Output shaft

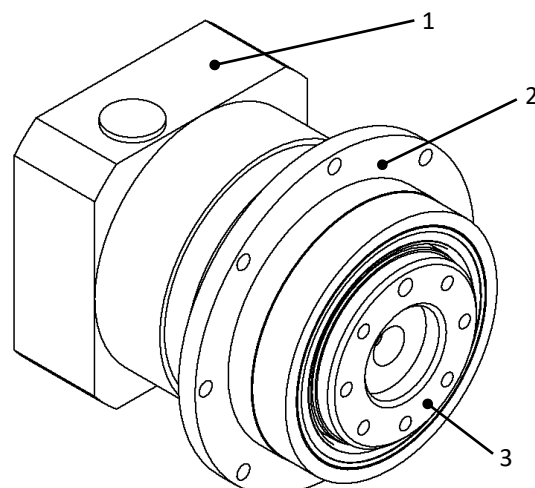

- 1: Adapter plate for motor assembly
- 2: Gearbox housing
- 3: Output flange

3.2 Lubrication

Grease: Tribol GR100-0PD Manufacturer: Castrol

Under normal operating conditions, the grease used serves as permanent lubrication based on 15.000 operating hours or 3 years. If the temperature is above 90°C during continuous operation or if there are very large temperature fluctuations due to extreme operating cycles, the lubricant change is required after 10.000 operating hours.

In the event of damaging the shaft sealing rings, resulting in a loss of grease, a factory repair and inspection is necessary.

3.3 Operating temperature

The operating temperature of the standard gearbox is in the range from -25°C to +90°C. Operating temperatures above or below the specified range are only permitted with special precautions. Please contact us in these cases.

3.4 Technical data

The technical data of the respective planetary gearboxes can be found in the current product catalog, the technical datasheet or our website: www.eisele-getriebe.de

4 Delivery and handling

4.1 Delivery condition

The planetary gearboxes are packed in safe and appropriate packaging. Transport damage must be reported to the shipping company immediately upon receiving the delivery. All packaging materials must be disposed of at the designated disposal points, the country-specific requirements must be met.

The complete scope of delivery of the planetary gearboxes is noted on the enclosed delivery note. The planetary gearboxes are to be checked for completeness immediately after receiving the delivery. Please contact us directly in case of missing or incorrectly delivered parts.

4.2 Transport

The planetary gearboxes do not contain any transport devices. Transport the planetary gearboxes preferably in the delivered packaging in order to avoid possible transport damage. During the entire transport, it must be ensured that the permissible storage temperature (see chapter 4.3) is not exceeded and that the packaging is protected from moisture.

Please note: The planetary gearboxes can be damaged by improper transport, e.g. by putting them down too hard.

	<p>⚠ Attention!</p> <p>When transporting and handling the planetary gearboxes, there is a risk of crushing due to their weight.</p> <ul style="list-style-type: none">▪ Only suitable means of transport and lifting gear may be used for transport.▪ Suitable safety equipment, for example, safety shoes and safety gloves, must be worn.
---	---

4.3 Storage

The planetary gearboxes should be stored in the original packaging or in a horizontal position in a dust-free and dry environment and in a temperature range between -10°C and +40°C. Storing outdoors is not permitted. The planetary gearboxes can be stored for up to 2 years if these storage conditions are kept.

5 Assembly and Installation

The gearing tolerances of low backlash planetary gearboxes must be very precise and require a very exact installation of the motor pinion in the planetary gearbox, in order to guarantee good operating noises, operating efficiency and prevent potential wear. Therefore, the concentricity of the motor shaft, the coaxiality and the axial runout of the mounting flange of the drive motor must comply with DIN 42955-R.

5.1 Motor assembly

- a) Check motor flange and motor shaft regarding compliance with tolerances according to DIN 42955-R.
- b) Remove eventual damages (dents, ridges)
- c) Check the gearbox motor flange for damage and remove eventual damage.
- d) Carefully slide the planetary gearbox onto the motor while applying slight pressure.
- e) Tighten the screw of the clamping hub coupling with the specified torque.
- f) Tighten the connecting screws between the motor and the planetary gearbox crosswise.

If the motor flange does not comply with DIN 42955-R, increased operating noises and wear can be expected, which will reduce the life time of the gearbox. The values in the technical data can then no longer be regarded as binding.

A detailed description of the motor assembly is provided in the respective assembly instructions. These are available on the internet at www.eisele-getriebe.de

5.2 Attaching couplings, toothed pulleys, etc.

Couplings, pulleys, gear wheels, sprocket wheels etc. are to be mounted up onto cleaned or lightly greased shafts with the help of the axial threaded hole in the gearbox output shaft or by heating. Pressing or knocking on can cause bearing damage and must be avoided.

5.3 Installation

The planetary gearboxes are sealed on all sides and can be installed in any mounting position.

The mounting seats (centering) and contact surfaces must be undamaged and clean. The shafts which are to be connected must be in exact positional accuracy to the contact surfaces in order to prevent damaging loads due to misalignment for bearings, shafts and housing in the overall system.

6 Commissioning and operation

6.1 Precautions before commissioning

Before commissioning the planetary gearboxes, the following requirements must be met.

- All safety instructions must be taken care of.
- Assembly and installation must have been carried out in accordance with the descriptions above.

6.2 Operating temperature

When operating the planetary gearboxes, the surface heats up.

	⚠ Attention!
	<p>Planetary gearboxes heat up during operation, through which all surfaces heat up. Touching the planetary gearboxes can cause burns.</p> <ul style="list-style-type: none">▪ All accessible areas of the planetary gearboxes must be secured by fixtures or warning signs.▪ Before touching the planetary gearbox, e.g. for work on the drive, one must wait until the surface has cooled down.

Overheating of the planetary gearbox can damage the lubricant and the seals in particular. During commissioning, check that the surface temperature does not exceed the maximum permissible temperature after several hours of operation. The operating temperature is given in the technical data (see chapter **Fehler! Verweisquelle konnte nicht gefunden werden.**).

6.3 Sound emission

The sound emission of the planetary gearbox varies depending on the size, design and installation situation. The maximum running noise can be found in the technical data (see chapter **Fehler! Verweisquelle konnte nicht gefunden werden.**). It should be considered that the noise emission of the entire drive, meaning the motor + planetary gearbox + add-on parts, is significantly influenced by the damping behavior of the entire system.

Increased running noise can be caused by an incorrect installation of the planetary gearbox. If the specified maximum running noise is exceeded, the installation of the planetary gearbox must be checked, otherwise there is a possibility of damaging the planetary gearbox or the entire system.

7 Maintenance

Sliding and rolling friction cause a certain amount of abrasion on certain gearbox components such as bearings, shaft seals and toothings over the course of the operational time. This abrasion is reduced to a minimum through the use of the lubricant and therefore extends the service life of the planetary gearbox components.

The selection of the gearbox size depends on the transmission power and the bearing load. If the gearbox is selected correctly, the load on the gear teeth is within the fatigue strength range of the gear material. Pitting or fatigue failure in the toothings are therefore excluded.

7.1 Maintenance intervals

The planetary gearboxes have a lifetime lubrication. The planetary gearboxes are maintenance-free under appropriate operating conditions within the technical specifications. If the gearbox is selected correctly, the service life of the gearbox bearings corresponds to the expected service life of the machine. The elements relevant for testing are limited to the gearbox grease and the shaft sealing rings.

The service life of the shaft seal used depends on various factors such as rotational speed, temperature, grease quality and environmental conditions. After 10.000 operating hours, we recommend regularly carrying out visual inspections of the planetary gearbox every 5.000 operating hours. If leakage is detected on the drive or the output, a replacement is required at short notice.

7.2 Grease change

As described in chapter 3.2, under normal operating conditions, a grease change is required after 15.000 operating hours or after 3 years. In order to change the gearbox grease, the planetary gearbox must be dismantled. We, therefore, advise having Eisele Antriebstechnik carry out the grease change.

7.3 Recommissioning after testing or maintenance

The outside of the planetary gearbox must be cleaned prior to recommissioning. All safety precautions required for testing and maintenance are to be removed. Chapter 6 must be paid attention to in order to ensure safe recommissioning.

8 Disposal

The planetary gearboxes are packed in a safe and appropriate packaging. All packaging materials must be disposed of at the designated disposal points, the country-specific requirements must be met.

The planetary gearboxes must be disposed of in accordance with the national regulations and laws. We recommend recycling the planetary gearboxes separately, according to the following raw materials:

- Steel
- Aluminum
- Plastic and sealing materials
- Lubricants

	Notice
	Leaking operating fluids and lubricants and improper disposal can cause environmental damage. <ul style="list-style-type: none">▪ All lubricants must be disposed of properly